

SYSTEMS

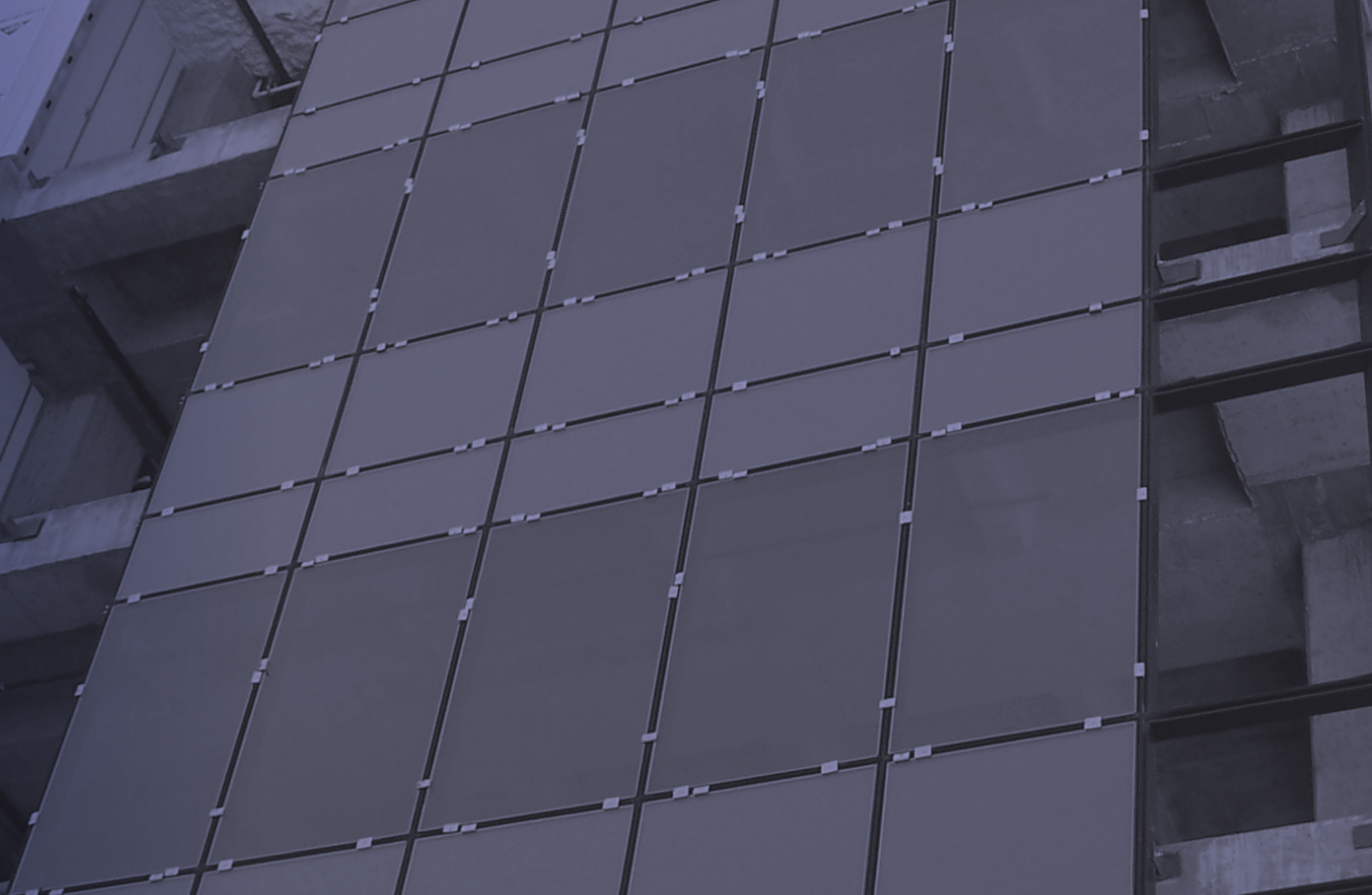

**SINGLE-SOURCE, COMPREHENSIVE GLAZING SOLUTIONS FOR IN-PLANT AND IN-FIELD**

GLAZING



# Trust Tremco

Protecting your reputation is how we've built ours

---

At Tremco, we know our reputation is directly tied to yours, so we're not just about making high-performance glazing products. Our deeper focus is on protecting and supporting the reputation of our customers for the long term. Since 1928, Tremco has pioneered superior weatherproofing solutions for architects, engineers, contractors, home builders, and building owners worldwide.



A leader in the glazing industry, our Ashland, Ohio facility is one of the top 5 specialty rubber and gasket extruders in North America, boasting a library of over 20,000 gasket profiles and producing over 250 million feet a year.

A producer of structural silicone sealants for more than 30 years, Tremco has built a reputation as a solutions provider for some of the most complex and innovative glazing projects in North America and around the world.



Milwaukee Art Museum, Milwaukee, WI

Burj Al Arab Tower Dubai,  
United Arab Emirates

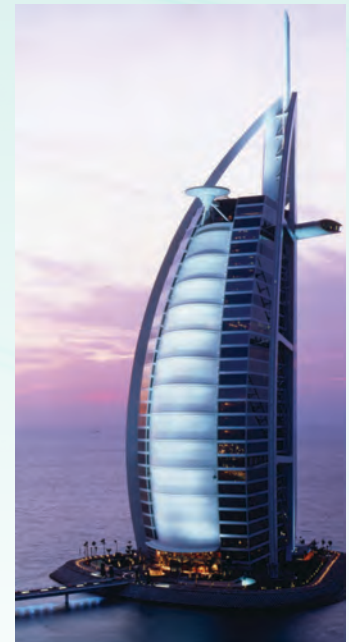

Tremco's longevity in the industry is enhanced by the strength of parent company RPM International, Inc. whose subsidiaries employ 13,000 people worldwide, manufacturing high-performance coatings, sealants and specialty chemicals in 116 facilities across 26 countries.



Design Integration & Collaboration



Experienced Technical Services



Documented System Performance

## Your Project Partner – Concept through Commissioning

Complete confidence comes from working with a supplier that truly understands every stage of the construction process beginning with the building concept through the design phase and culminating with occupancy and operations. Whether your latest project involves a basic storefront, a custom curtain wall or aggressive performance requirements, the experts at Tremco provide fully-tested, comprehensive solutions plus the design engineering and on-site project services you need to make it a success.



### Design Integration & Collaboration

Our Design Engineering Group, supported by a team of dedicated regional glazing specialists, combines expertise and leading-edge technology to customize options for your project, whether standard or complex including:

- Storefront design with a window-to-wall interface
- Custom curtain wall systems with complex geometries
- Meeting blast, impact or seismic resistance requirements
- Mitigating thermal conductivity

Leveraging our library of over 20,000 extruded rubber profiles, our team will create the optimal project-specific solution. State-of-the-art tools such as our 3D printing capabilities allow us to reduce turnaround time. Our design engineers provide support throughout the manufacturing process to ensure that the end result is a high-performing glazing system.

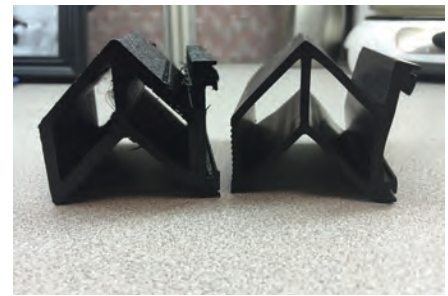
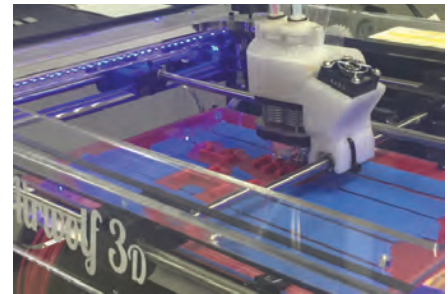



Knowledgeable Field & Site Support



Peace of Mind Guarantee



Restoration



## Experienced Technical Services

Our Technical Services team is involved in your project from concept through execution. We review and provide project-specific recommendations, drawing from decades of extensive testing specific to the most common construction materials. Tremco Technical Services representatives effectively enhance any glazing system through:

- ✓ Structural glazing review and recommendations
  - Evaluation of submitted project-specific shop drawings
  - Identification of required testing materials
- ✓ Testing including adhesion, compatibility and staining
- ✓ Sealant recommendations based on joint sizes, movement capability and compatibility



## Documented System Performance

Tremco eliminates the guesswork when it comes to detailing the critical connections across the building envelope. We provide local technical and field support for on-site mock-ups and other pre-construction testing. We also offer comprehensive system evaluation at our Sustainable Building Solutions Test Facility, designed in collaboration with the building science community. At our Test Facility, we can help you validate the performance of your glazing system so that modifications can be made before the construction phase when changes become difficult and more costly.

- Measurement of air leakage/moisture infiltration contributing to energy loss and sustainability
- Connectivity testing of critical transitions including window to wall
- Independent, third-party testing certification
- Design engineering support of testing and mock-up development including design and detail review





Design Integration & Collaboration



Experienced Technical Services



Documented System Performance



## Knowledgeable Field & Site Support

Tremco's regional glazing specialists, backed by our expansive network of technical representatives across North America, provide on-site service throughout the construction process:

- Submittal documentation and product specification review
- Project meetings regarding planning and installation sequencing
- Interface with Technical Services and Design Engineering
- Product installation training and mock-up construction assistance
- On-site observation and verification of job conditions



## Peace of Mind Guarantee

Our all-inclusive warranties provide confidence that your project's glazing system is backed by a company with more than 85 years' experience, success and proven performance in the industry. Tremco warranties are available to cover adjacent tie-ins and systems across the entire building envelope such as air barriers and window-to-wall transitions.



Knowledgeable Field & Site Support



Peace of Mind Guarantee



Restoration



BEFORE



AFTER



## Restoration

Our comprehensive, time-tested solutions, tailored to your specific project needs, will renew performance and extend the life of the glazing system. Dedicated local glazing resources supported by an experienced technical team design and deliver proven solutions for restoration projects ranging from the seemingly simple to the decidedly complex. Resources such as in-house 3D printing capabilities allow us to rapidly create and trial gasket prototypes.



^ To restore leaking skylights on the Puerto Rico Convention Center, design engineers created a restoration system comprised of a custom silicone overlay extrusion, Spectrem Simple Seal, and Spectrem 1 Silicone Sealant.

## Propagating Best Practices

Our dedicated Building Envelope Solutions Team focuses on integrated design, testing, construction, and site support for high performance buildings. In conjunction with Tremco's Technical Services and Design Engineering professionals, they collaborate in the development of custom solutions for the most complex connectivity challenges.

Other functions of BEST include:

- ✔ Industry engagement
- ✔ Best practice education
- ✔ National project and account coordination



## Project Profiles

### Parkland Hospital *Dallas, Texas*

For optimum performance, glazing systems should be designed as complete and unified assemblies. The custom unitized four-sided structurally glazed wall system at Parkland Hospital incorporated a single-source approach to ensure success. The window fabricator, Win-Con Enterprises, used Tremco's two-component Proglaze® II Structural Silicone Sealant because of its high performance properties in conjunction with the appropriate glazing gaskets and spacers developed by Tremco's design engineers. Spectrem® 2 Silicone Sealant was then applied in the field as a weatherseal. In addition to Tremco's extensive experience in design to accommodate the movement of various materials and other performance requirements, our local sales representatives provided the necessary field support, job-specific details and on-site inspections for proper integration and detailing. For this project, Tremco also supplied the air barrier system, window-to-wall interface, and below-grade waterproofing for a continuous, compatible building enclosure.



### Tremco Solutions

- ✔ Proglaze® II Structural Silicone Sealant
- ✔ Proglaze® SSG Structural Silicone Glazing Sealant
- ✔ Tremco Gaskets
- ✔ Spectrem® 2 Silicone Sealant
- ✔ Proglaze® ETA



## Toronto BMW

### Toronto, Ontario

On a 10-acre site in Toronto, BMW created an innovative luxury car dealership with a configuration that is unprecedented in the automotive industry. With structural glazing on three sides, the building stands like a billboard taking full advantage of the exposure to the nearby highway. The design features clean sight lines and expanses of vision glass 10' (3 M) wide by 14' (4.3 M) high. In transit from the plant to the BMW site, it was critical that all components stay intact. For the viewing windows on the fourth and fifth floors, getting the glass into position and installed were additional challenges. The butt-glazed feature wall was created using glass support fins, 'spiders' and structural silicone sealant. The complexity and demands of the job left no room for problems of any type, so Applewood/JTI turned to Tremco for all the glazing components. From past experience, they knew compatibility was assured and schedules would be met because of Tremco's full-service solutions.

### Tremco Solutions

- ✓ Proglaze® II Structural Silicone Sealant
- ✓ Spectrem® 2 Silicone Sealant
- ✓ Tremco SCR Silicone-Compatible Rubber Extrusions
- ✓ POLYshim® II Tape

## Puerto Rico Convention Center

### San Juan, Puerto Rico

Over time, the Puerto Rico Convention Center's expansive upper skylight system has been put to the test in this tropical climate. The combination of movement and exposure to the elements had impacted the glazing seal at various points along the framework and hurricane clips of the system, causing many leaks throughout the structure. Design engineers from Tremco created a glazing restoration system comprised of Spectrem® Simple Seal, a custom silicone overlay extrusion and Spectrem® 1 Silicone Sealant. In addition to stopping the leaks, the solution provided considerable labor savings as the efficiencies of this install allowed the applicator to complete more than 800 lineal feet of the gasket overlay system per day. The entire project was wrapped up in 94 continuous work days by National Building Contractors.



### Tremco Solutions

- ✓ Spectrem® Simple Seal Extruded Silicone Bridge
- ✓ Spectrem® Silicone Overlay Gasket
- ✓ Spectrem® 1 Silicone Sealant



# Core Competencies

## Wet Glazing

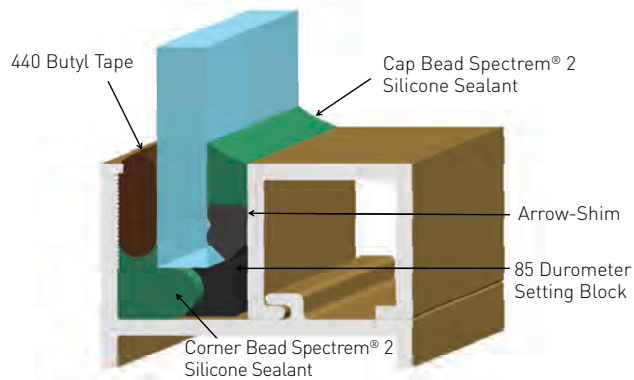

## Hurricane/Impact Glazing

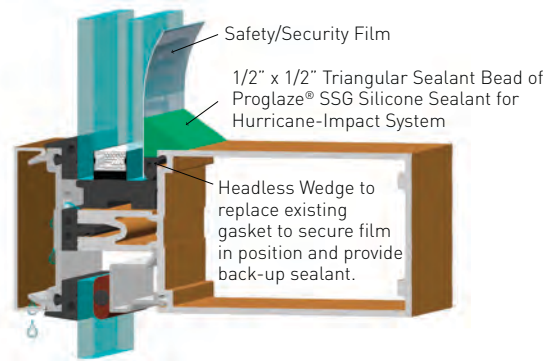

## Wet-Dry Glazing

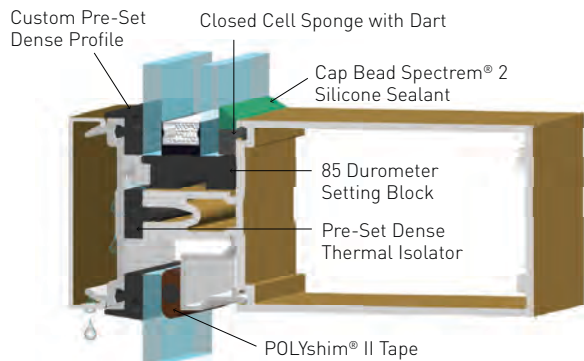

## Plastic Glazing

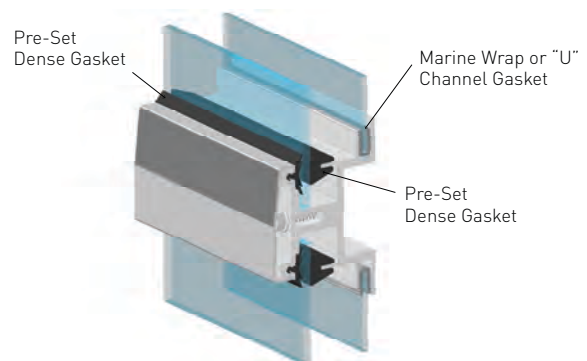

## Dry Glazing

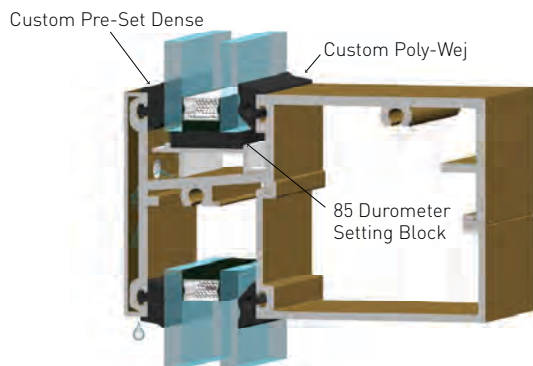

## Sloped Glazing

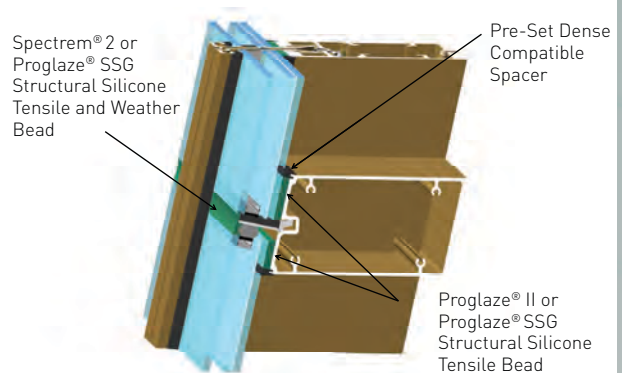

## Structural Silicone Glazing

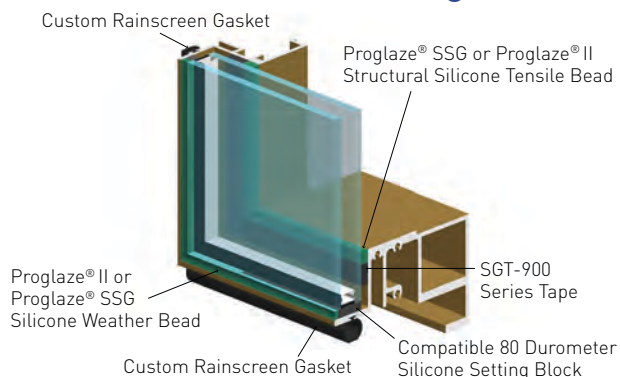

## Restoration

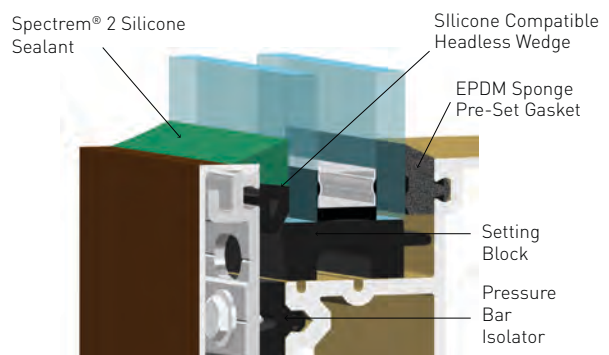



3735 Green Road  
Beachwood, OH 44122  
216.292.5000 • 800.321.7906

1451 Jacobson Avenue  
Ashland, OH 44805  
800.321.6357

220 Wicksteed Avenue  
Toronto, ON M4H 1G7  
416.421.3300 • 800.363.3213